

The MSS Series

Security Contacts are made with a decades-old technology called the Reed switch. Reed switches have three inherent weaknesses when used in security contacts -- they are: Easily defeated with magnets, Prone to permanent contact weld failure (from lightning and power surges), and fragile (made mostly of glass, they are subject to damage even when packaged as security contacts).

The MAGNASPHERE MSS line of security sensors provides a solution to all of these issues. Because the sensors incorporate a true Form B switch, they are installed in an Open Loop electrical configuration. This is the same configuration required for other life safety devices such as smoke and fire alarms, and has long been the recommend configuration by most knowledgeable security professionals.

The unique switch utilized in these devices renders the MSS products **virtually unbreakable, and highly resistant to permanent contact welding and outsider magnet defeat**, allowing MAGNASPHERE to offer an industry leading product warranty.

MODEL MSS-19C 3/4" Concealed Security Sensor



MODEL MSS-25C 1" Concealed Security Sensor



MODEL MSS-63S Surface-Mounted Security Sensor



MAGNASPHERE®

MODEL MSS-19C

3/4" Concealed Security Sensor

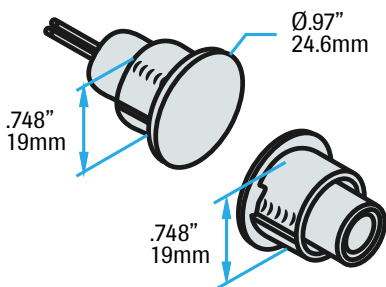

MODEL MSS-25C

1" Concealed Security Sensor

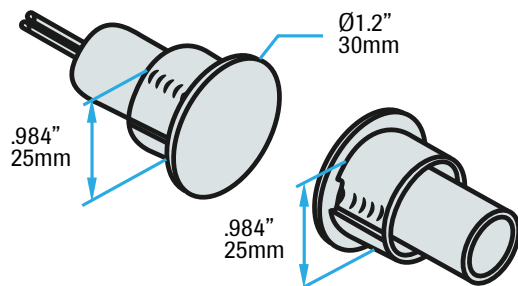

MODEL MSS-63S

Surface-Mounted Security Sensor

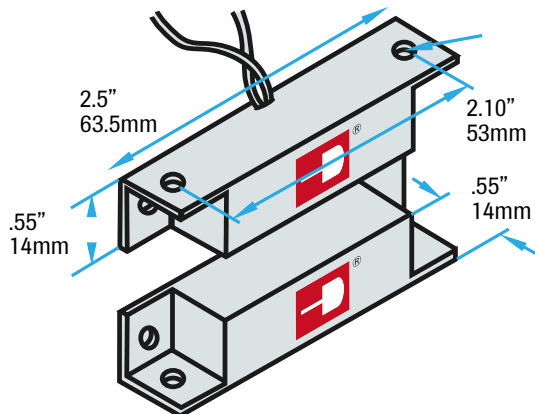

Features

- Installs in Fail Safe (open loop) mode
- Made with MAGNASPHERE® BMS switch technology
- Won't break
- Resistant to contact welding
- Resistant to outside defeat
- Security industry's BEST warranty
- Universal mounting
- Cost competitive
- Increases RMR

Specifications

- Contact Form: Open Loop
- Max Electrical Rating:
 - 250mA
 - 30 VDC (resistive)
 - 0.25W
- Leads: 22 AWG x 12"
- Use of EOL resistor recommended

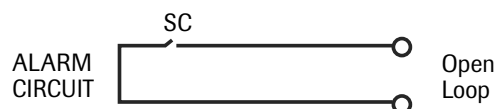

Reed vs. MAGNASPHERE®



Security contacts are made with a decades-old technology called the Reed switch.

Reed switches have three inherent weaknesses when used in security contacts: (1) **Easily defeated with magnets**, (2) **Prone to permanent contact weld failure** (from lightning and power surges), and (3) **fragile** (made mostly of glass, they are subject to damage even when packaged as security contacts).

SECURE: NO ALARM

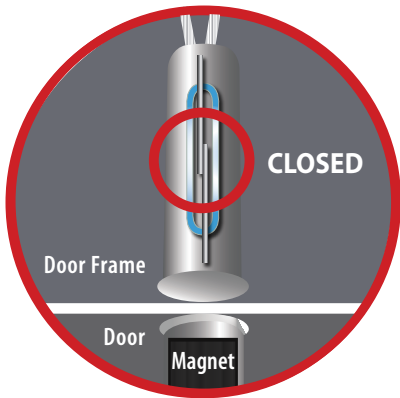

Reed contacts operate on magnetic fields. Most contacts are Closed in the secure position (Closed Loop) when the door is closed and the magnet is near the switch.

FAILED: NO ALARM

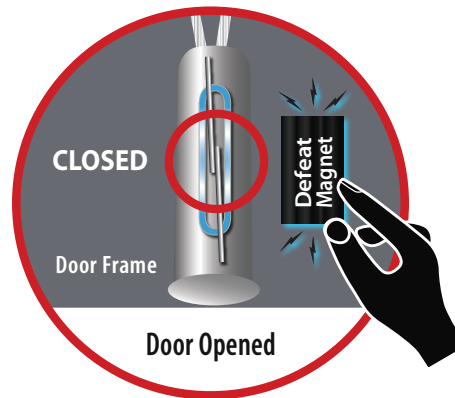

Reed switch contacts are globally magnetic: they will respond to the strongest magnetic field anywhere around the contact -- not solely to the door magnet. When compromised, reed contacts will still send secure signals.

Introducing a defeat magnet OUTSIDE the door will keep the reed contacts closed, allowing an intruder to enter without alerting the security system. They **FAIL SECURE**.



NO ALARM

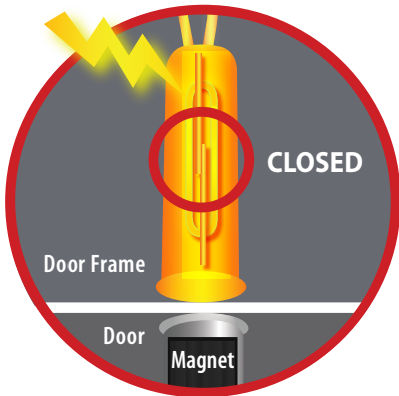

When closed reed contacts are exposed to power surges such as lightning strikes, they are prone to permanent contact welding.

FAILED: NO ALARM

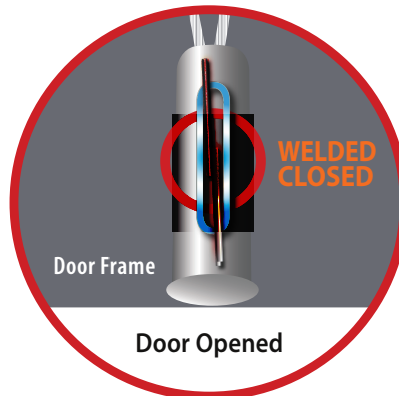

Reed contacts operate by magnetic induction, so they are not attracted to the door magnet.

Once contacts have welded closed, they remain in that state though the door is open. They **FAIL SECURE**.

Reed vs. MAGNASPHERE®

The patented, award-winning MAGNASPHERE switch technology was designed as a security device which over comes the deficiencies of reed contacts. The MAGNASPHERE switch is (1) **Resistant to magnetic defeat and tamper**, (2) **Resistant to permanent contact welding** from lightning and power surges, and (3) Robust, all metal welded construction is **virtually unbreakable**.

SECURE: NO ALARM

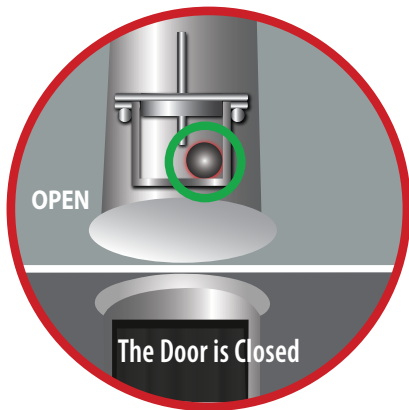

MAGNASPHERE security sensors' magnet ball contact is open in the secure position (Open Loop) when the door is closed and the door magnet is near the switch.

ALARM

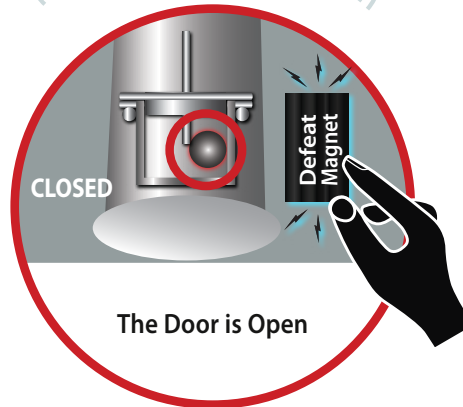

A defeat magnet introduced OUTSIDE the door will have no effect on the ball contact. When the door is opened, the contact will close, and the **SYSTEM WILL ALARM**.

MAGNASPHERE's contact is a spherical magnet and operates in a defined activation zone directed toward the door magnet.



NO ALARM

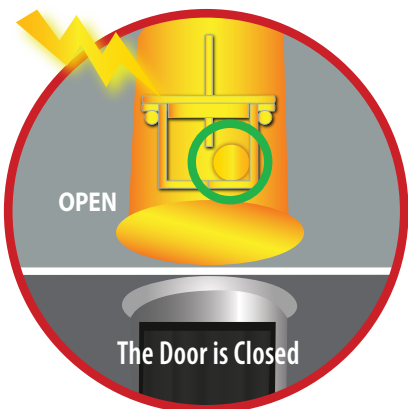

MAGNASPHERE Security Sensors are Open Loop and highly resistant to contact welding from power surges and lightning strikes.

ALARM

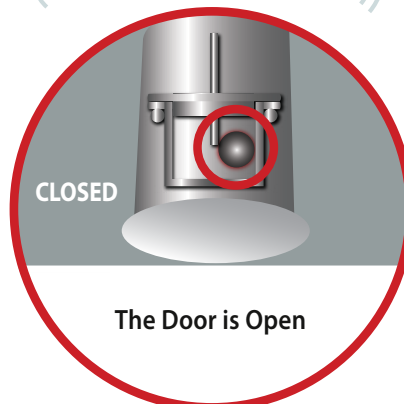

Because the magnet ball contact will not weld, when the door is opened the contact will close and the **SYSTEM WILL ALARM**.